

Micro S - CAMPO DI APPLICAZIONE APPLICATION FIELD



Finestre a sporgere
Top hinged windows



Finestre a vasistas
Bottom hinged windows



Finestre a bilico
Pivot windows



Lucernari
Skylights

L'attuatore deve essere installato all'interno dell'edificio
The actuator has to be installed indoor

Micro S - DESCRIZIONE DI CAPITOLATO DESCRIPTION OF SPECIFICATIONS

MINGARDI Attuatore elettrico lineare a catena articolata contenuta all'interno dell'involucro. Funzionamento con tensione di alimentazione 230V AC 50Hz o 24V DC. Conforme alle Direttive Europee di riferimento. Dotato di sistema di fine corsa elettronico in apertura e ad assorbimento in chiusura. Collegabile in parallelo. Colori disponibili: anodizzato argento (A) - anodizzato nero (N) - RAL 9003 (B).

MINGARDI linear electric actuator with reinforced double-sprocket chain inside the actuator body. Operating voltage: 230V AC 50Hz or 24V DC. In compliance with the relevant European Directives. Equipped with electronic limit switch system for opening and closing absorption. Can be connected in parallel. Colours available: anodised silver (A) - anodised black (N) - RAL 9003 (B).

Micro S - CARATTERISTICHE TECNICHE TECHNICAL FEATURES

Forza / Force	Spinta / Thrust: 200N - Trazione / Tensile: 200N
Voltaggio / Voltage	230V AC 50Hz o/or 24V DC
Fine corsa apertura e chiusura / Limit switch opening and closing	Elettronico-assorbimento / Electronic-absorption
Grado di protezione (per uso interno) / Protection degree (indoor use only)	IP 20
Temperatura di funzionamento / Operating temperature	-10°C + 40°C
Cavo / Cable	PVC Nero / Black L. 1200 mm
Certificazioni / Certifications	CE

Micro S 230V - LUNGHEZZE LENGTHS

Corsa / Stroke	200 mm	L1 = 324 mm	L2 = 341 mm
Corsa / Stroke	250 mm	L1 = 349 mm	L2 = 366 mm

Micro S 24V - LUNGHEZZE LENGTHS

Corsa / Stroke	200 mm	L1 = 224 mm	L2 = 261,4 mm
Corsa / Stroke	250 mm	L1 = 269 mm	L2 = 286,4 mm

Corpo attuatore in alluminio.
Anodizzato Argento - Anodizzato Nero - Bianco RAL 9003
 Aluminium actuator casing.
 Anodized Silver - Anodized Black - White RAL 9003

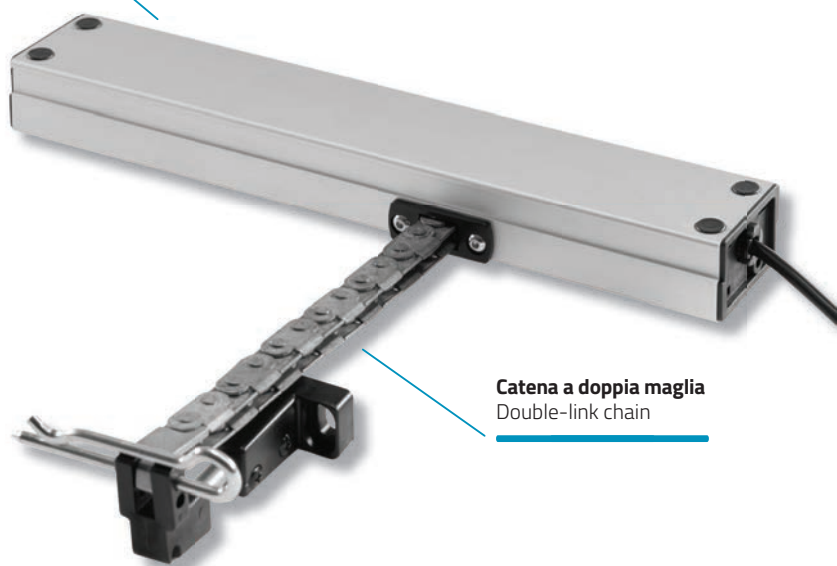

Catena a doppia maglia
Double-link chain

Micro S - DIMENSIONALI 230V AC 50Hz DIMENSIONS 230V AC 50Hz

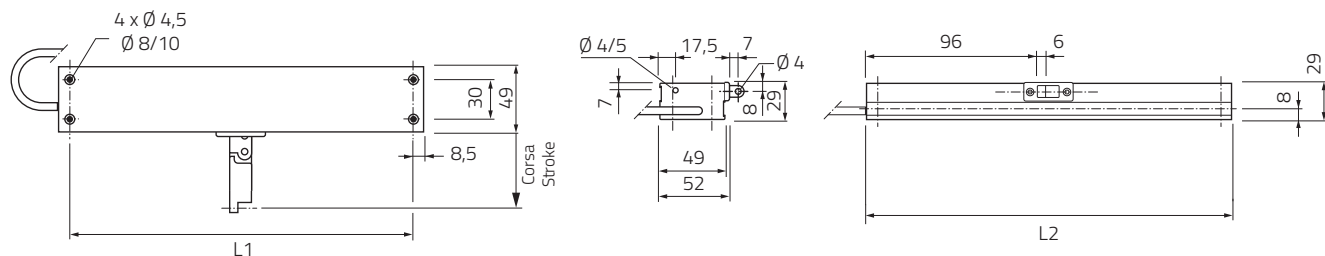

Micro S - 230V AC 50Hz

CODICE CODE	DESCRIZIONE DESCRIPTION	CORSA STROKE	SPINTA/TRAZIONE THRUST/TENSILE	POTENZA POWER	GRADO DI PROTEZIONE PROTECTION DEGREE	VELOCITA' MIN. SPEED MIN.	COLORE COLOR
2700115	Micro S	200 mm	200 N	30 W	IP 20	ca. 10 mm/s	Argento / Silver
2700552	Micro S	200 mm	200 N	30 W	IP 20	ca. 10 mm/s	Nero / Black
2700327	Micro S	200 mm	200 N	30 W	IP 20	ca. 10 mm/s	Bianco / White
2700055	Micro S	250 mm	200 N	30 W	IP 20	ca. 10 mm/s	Argento / Silver
2700567	Micro S	250 mm	200 N	30 W	IP 20	ca. 10 mm/s	Nero / Black
2700328	Micro S	250 mm	200 N	30 W	IP 20	ca. 10 mm/s	Bianco / White

Micro S - DIMENSIONALI 24V DC DIMENSIONS 24V DC

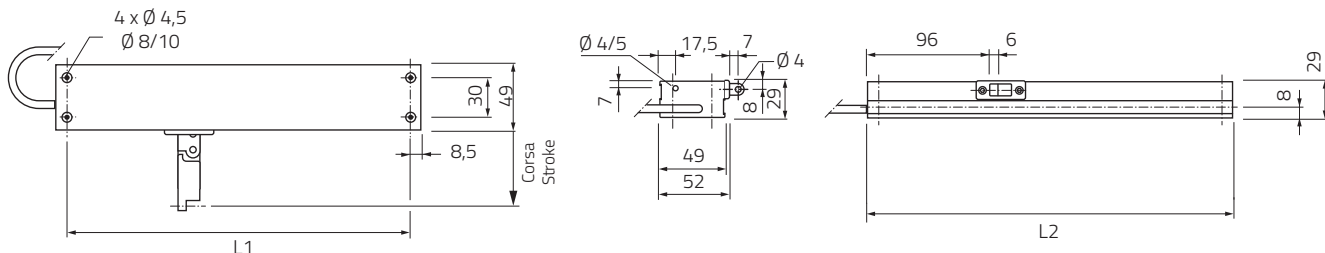

Micro S - 24V DC

CODICE CODE	DESCRIZIONE DESCRIPTION	CORSA STROKE	SPINTA/TRAZIONE THRUST/TENSILE	POTENZA POWER	GRADO DI PROTEZIONE PROTECTION DEGREE	VELOCITA' MIN. SPEED MIN.	COLORE COLOR
2700116	Micro S	200 mm	200 N	20 W	IP 20	ca. 10 mm/s	Argento / Silver
2700562	Micro S	200 mm	200 N	20 W	IP 20	ca. 10 mm/s	Nero / Black
2700329	Micro S	200 mm	200 N	20 W	IP 20	ca. 10 mm/s	Bianco / White
2700117	Micro S	250 mm	200 N	20 W	IP 20	ca. 10 mm/s	Argento / Silver
2700578	Micro S	250 mm	200 N	20 W	IP 20	ca. 10 mm/s	Nero / Black
2700330	Micro S	250 mm	200 N	20 W	IP 20	ca. 10 mm/s	Bianco / White

I valori prestazionali riportati nelle tabelle sono valori medi verificati in condizioni di utilizzo standard / The values indicated on the tables are average values were recorded in condition of normal use

Micro S - ACCESSORI DI FISSAGGIO FIXING ACCESSORIES

CODICE CODE	DESCRIZIONE DESCRIPTION
2700093	Kit universale per applicazioni su finestre a sporgere / Universal kit for fitting top-hinged windows
2700094	Kit universale per applicazioni su finestre a vasistas / Universal kit for fitting bottom-hinged windows
2700096	Kit universale per applicazioni su finestre a / Universal kit for fitting roof windows
2700080	Staffa basculante per applicazioni su bancale / Pivoting bracket for horizontal plane applications

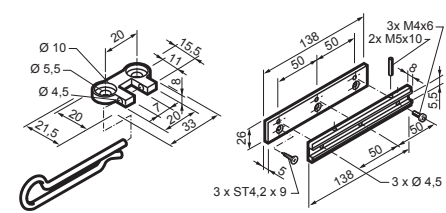

2700093

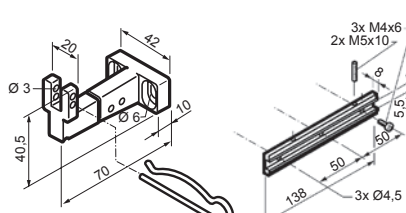

2700094

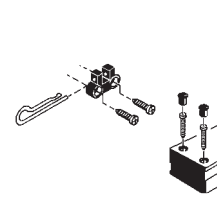

2700096

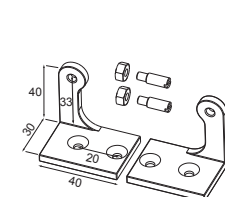

2700080